

Sezione orizzontale Unirev REI 60 / REI 120 ad una anta

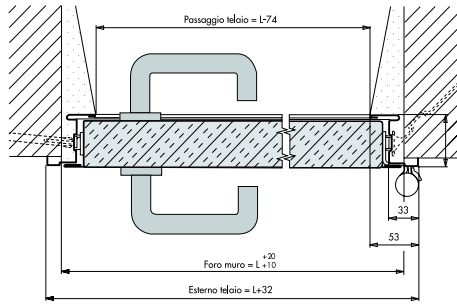

Tagliafuoco REI 60 spessore anta 50 mm
 Tagliafuoco REI 120 spessore anta 60 mm

Sezione orizzontale Unirev REI 60 / REI 120 a due ante

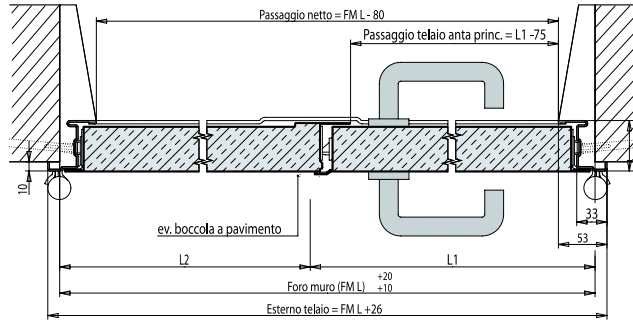

Sezione verticale REI 60 / REI 120

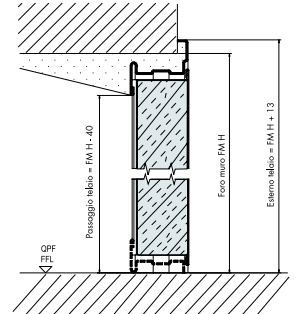

Ingombri massimi Unirev REI 60 / REI 120

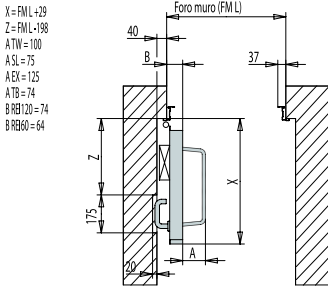

Ingombri massimi per porte ad una anta con apertura a 90°.

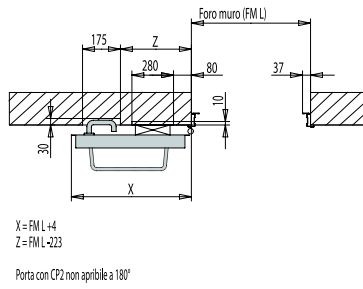

Ingombri massimi per porte ad una anta con apertura a 180°.

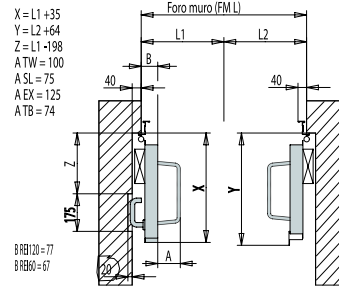

Ingombri massimi per porte a due ante con apertura a 90°.

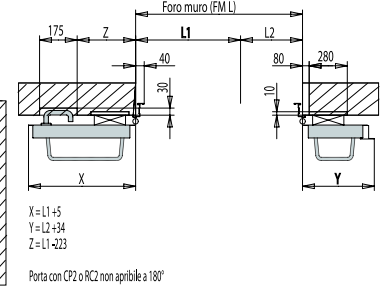

Ingombri massimi per porte a due ante con apertura a 180°.